



An Roinn Talmhaíochta,
Bia agus Mara
Department of Agriculture,
Food and the Marine



European Maritime
& Fisheries Fund



Ireland's European Structural and
Investment Funds Programmes
2014-2020

Co-funded by the Irish Government
and the European Union

EMFF Operational Programme 2014-20

Annual Implementation Report 2018

Keith Kelleher
EMFF Managing Authority
30 May 2019



An Roinn Talmhaíochta,
Bia agus Mara
Department of Agriculture,
Food and the Marine



European Maritime
& Fisheries Fund



Ireland's European Structural and
Investment Funds Programmes
2014-2020

Co-funded by the Irish Government
and the European Union

Presentation Structure

- Overview of EMFF OP 2014-2020 (Progress to Date, Highlights, Lesser Lights)
- Review of the Implementation of Union Priorities and Associated Schemes in 2018
- Performance Framework Update.
- Q&A

Overview

- ❖ Programme value €239.3 million
- ❖ Funds Committed €152 million (63.5% of programme)
- ❖ Public Expenditure declared in 2018 €43.5 million
- ❖ Estimated spend to end 2018 circa €100.8 million (42% of programme)
- ❖ Outlook for 2019 €50 million
- ❖ Data Collection funds 100% committed
- ❖ Control & Enforcement funds 71% committed



Support Provided under the
**European Maritime and Fisheries
Fund Operational Programme**

2014-2020



An Roinn Talmhaíochta,
Bia agus Mara
Department of Agriculture,
Food and the Marine



EUROPEAN UNION
This measure is part-financed
by the European Maritime
and Fisheries Fund



Progress to end 2018



European Maritime
& Fisheries Fund



An Roinn Talmhaíochta,
Bia agus Mara
Department of Agriculture,
Food and the Marine

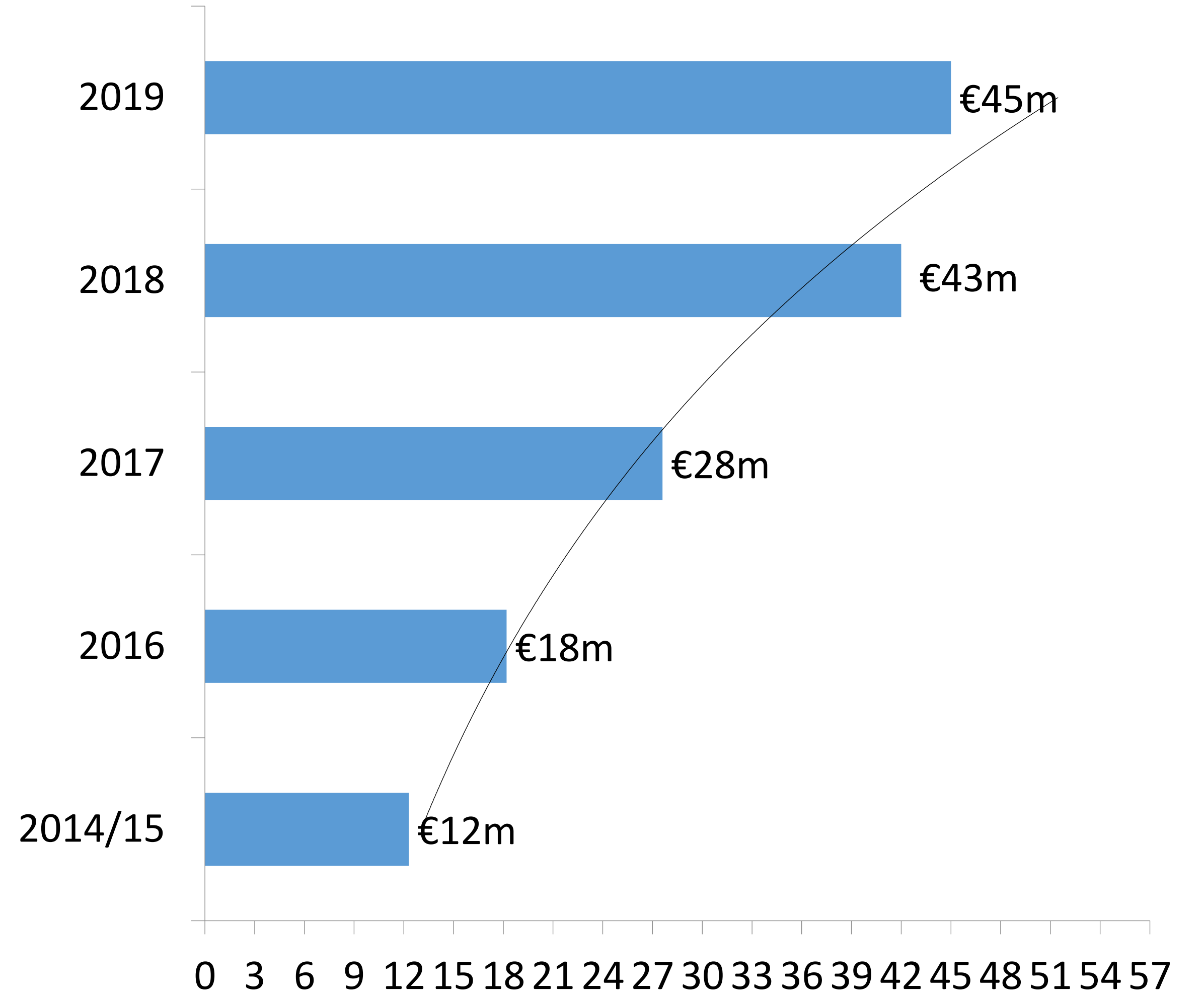
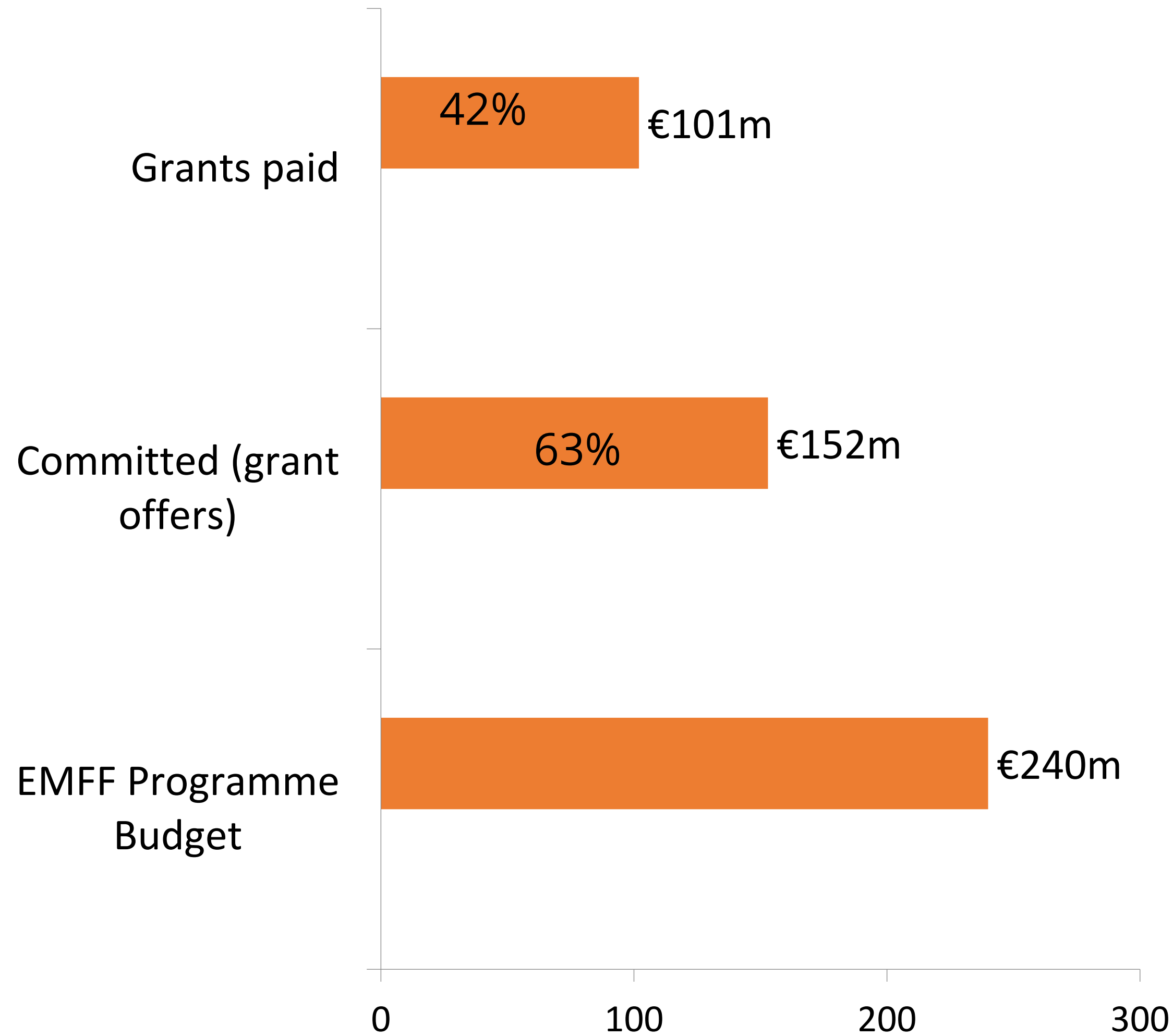

2018 Highlights

- ❖ 57% increase in spend to €43.5m in the period 2017 to 2018
- ❖ Achievement of the Performance Framework milestones for 2018.
- ❖ Strong interest in EMFF funding of innovation and research projects.
- ❖ A notable increase in capital investment in aquaculture as more sites are licensed.
- ❖ Investment of €7.6 million for improvements to two Fishery Harbour Centres under the EMFF Fishery Harbour Scheme.
- ❖ An increase in the scale of capital projects.
- ❖ The launch of the Seafood Capacity Building and Seafood Skills and Trainings Schemes.
- ❖ The development of a strong project pipeline.



2018 Lesser Lights

- ❖ No EMFF funds for Available for Data Collection after 2019.
- ❖ Suspension of EMFF funds for Control & Enforcement.
- ❖ Lack of applications for Seafood Capacity Building Scheme.
- ❖ Demand is running behind budget allocation for Aquaculture capital projects.



Expenditure 2018

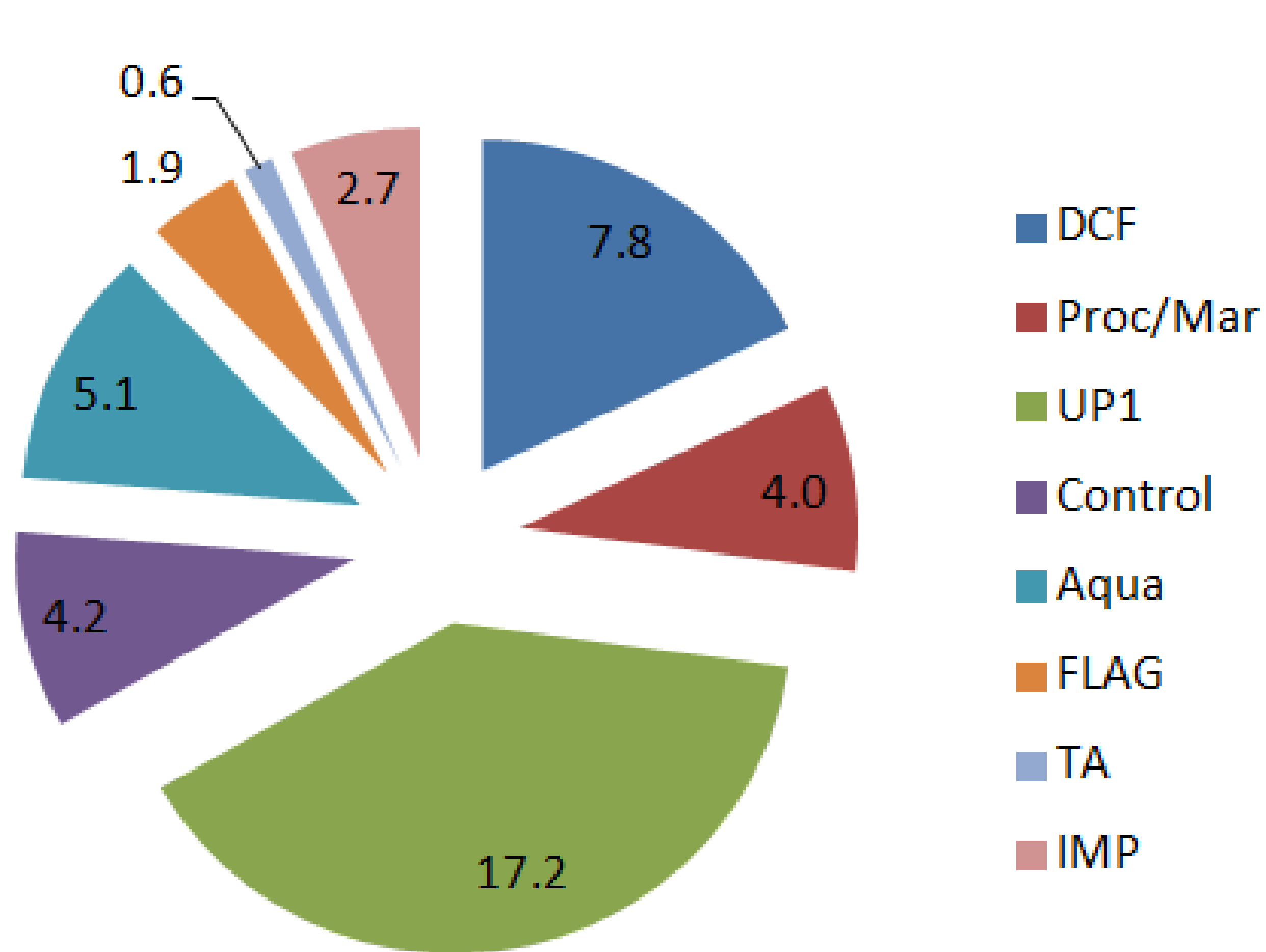

Spend - €43.5m

EU contribution - €25.8m

EU Recoupment Claims

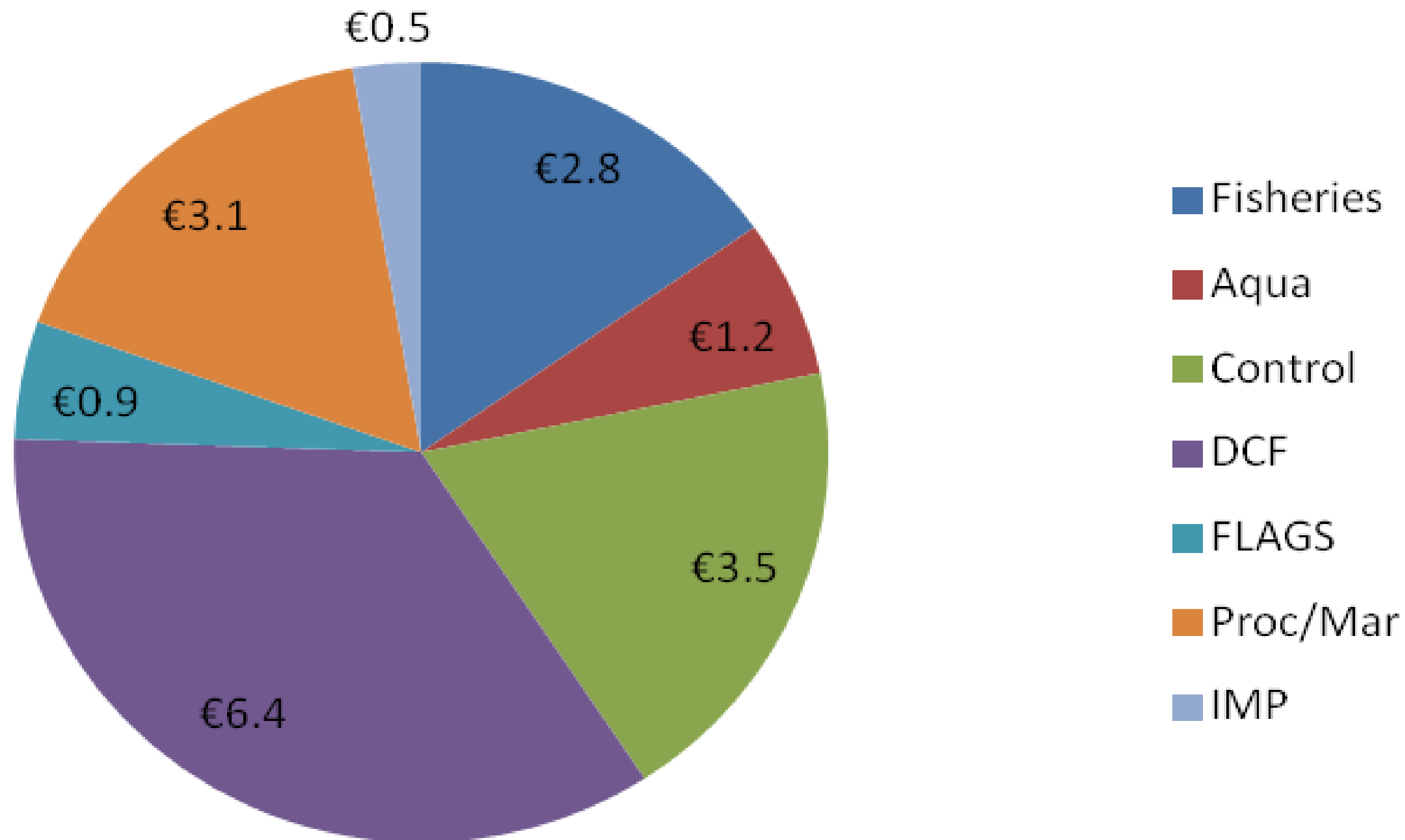

□ €18.4m claimed
□ €13.6m Received
□ €3.4m withheld re
Control ex-ante

UP1 Expenditure 2018

- Sustainable Fisheries
- Marine Biodiversity
- Seafood Innovation & Business Planning
- Seafood Skills & Training
- QB System
- New Fishermen
- Inshore Fisheries Con.
- Seafood Capacity Building
- Fishery Harbour

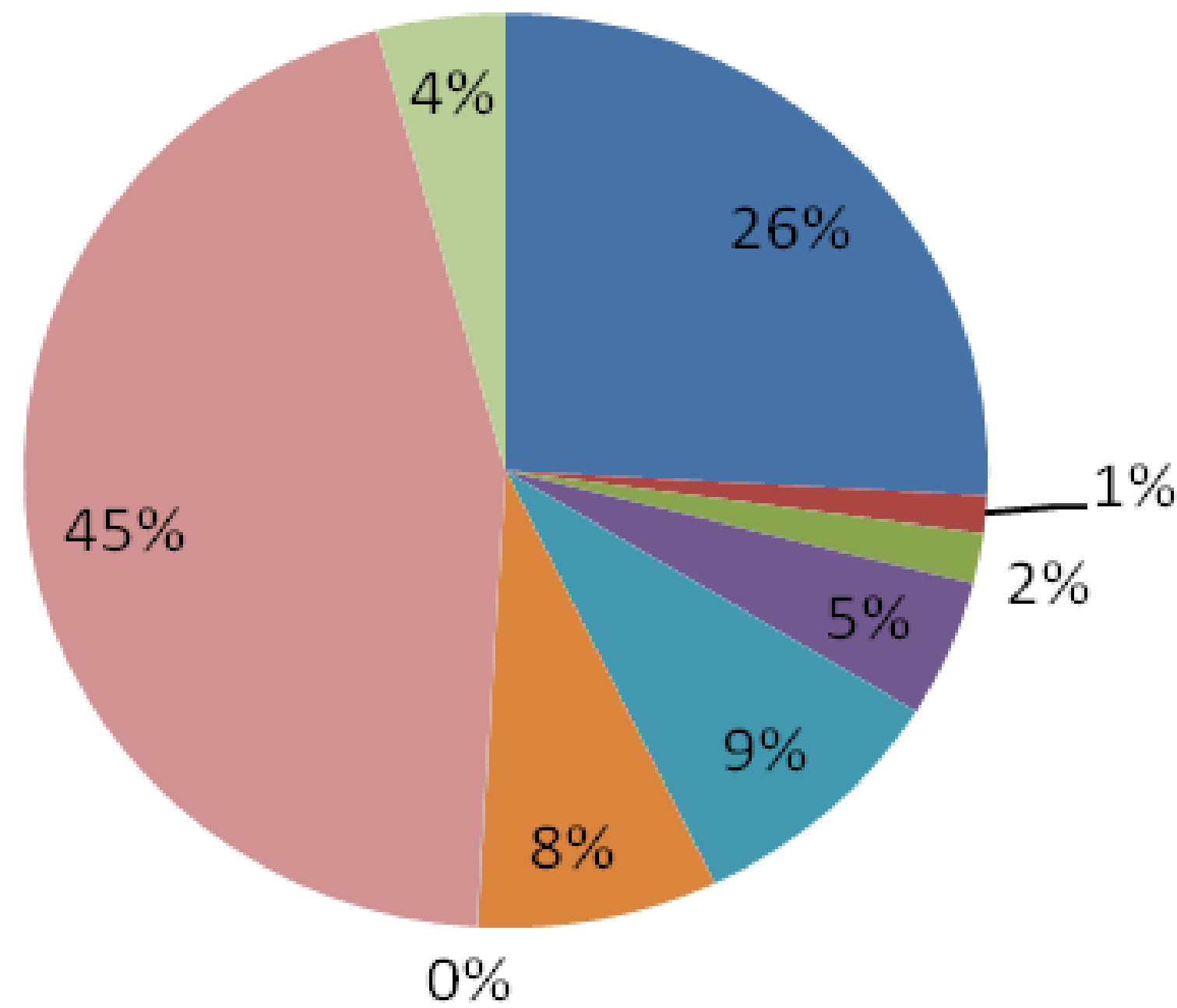

Sustainable Fisheries Scheme

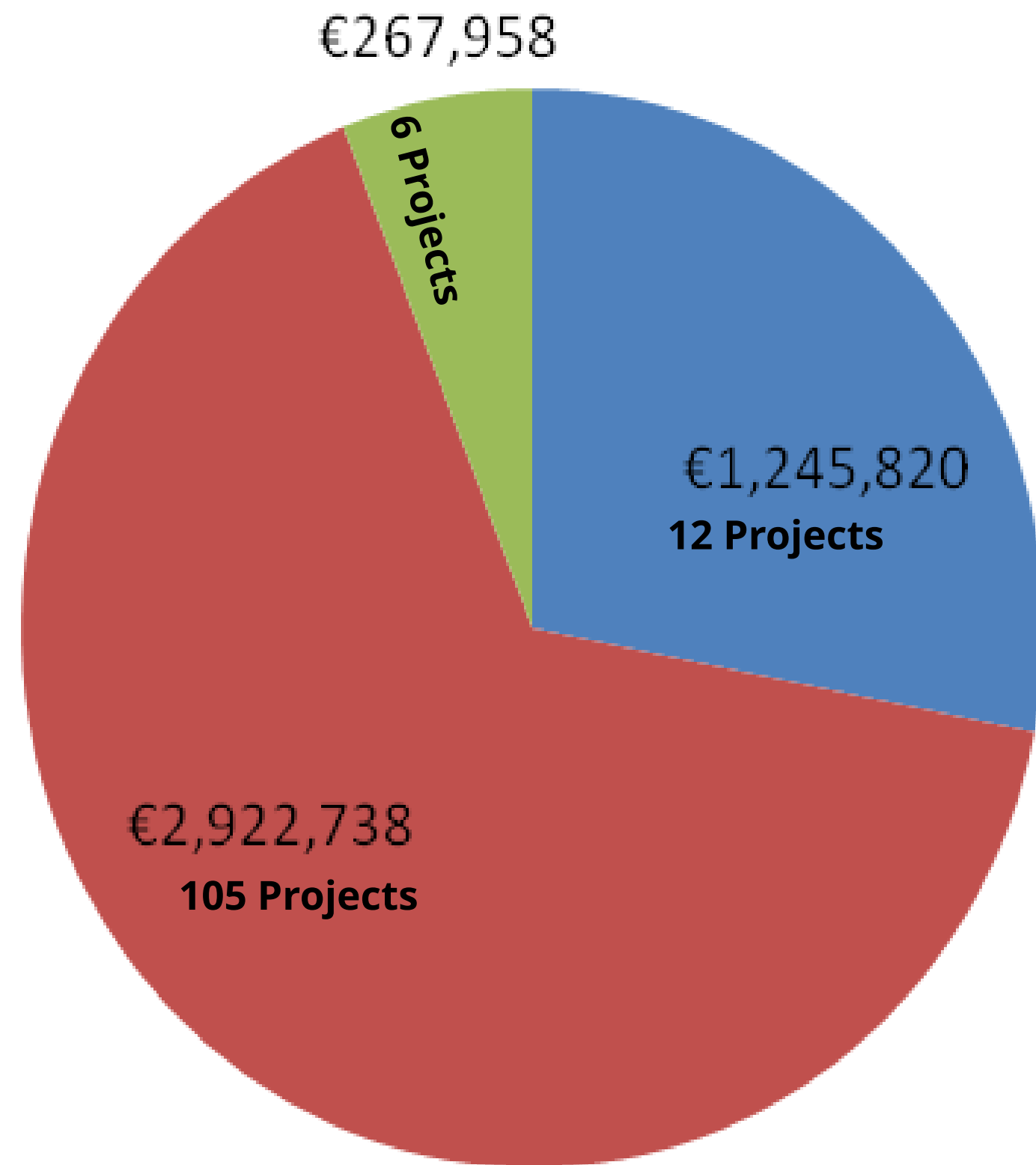

- Public Projects
- On-board
- Onshore

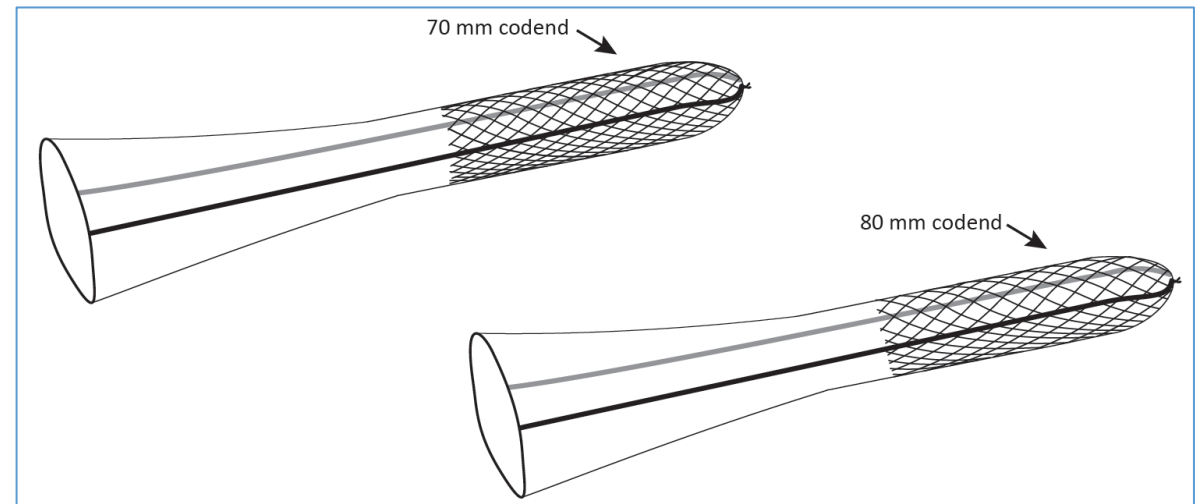

Investment - €4,436,516 123 Projects

Inshore Fisheries Scheme

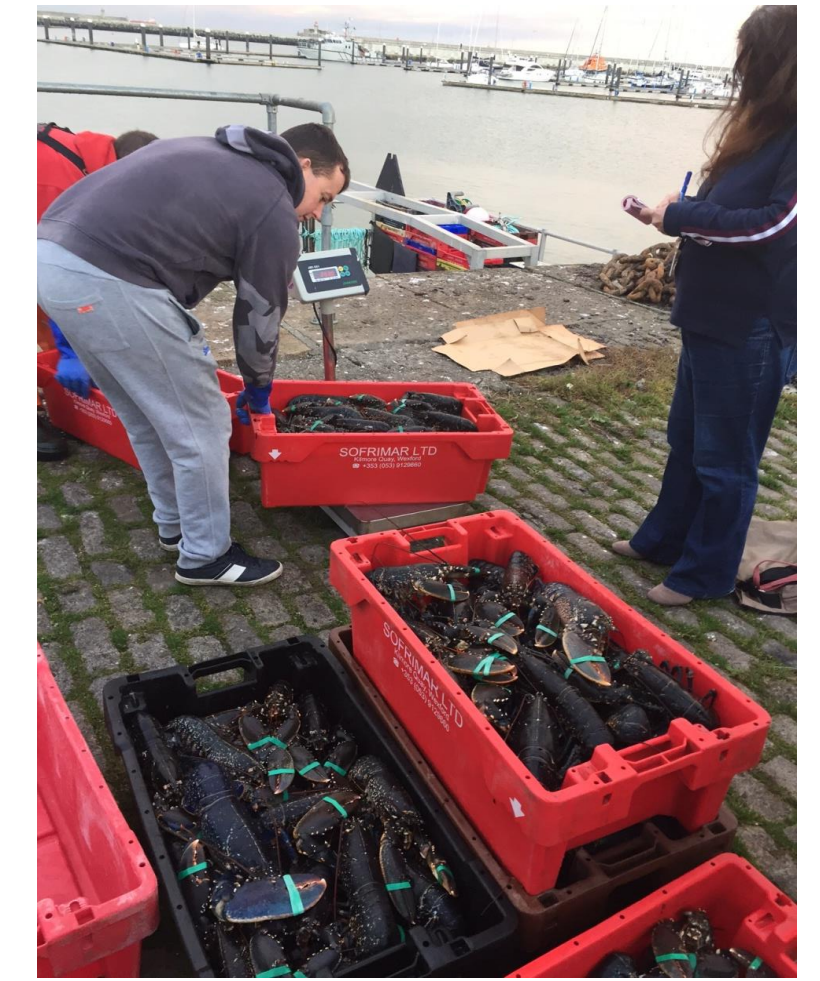
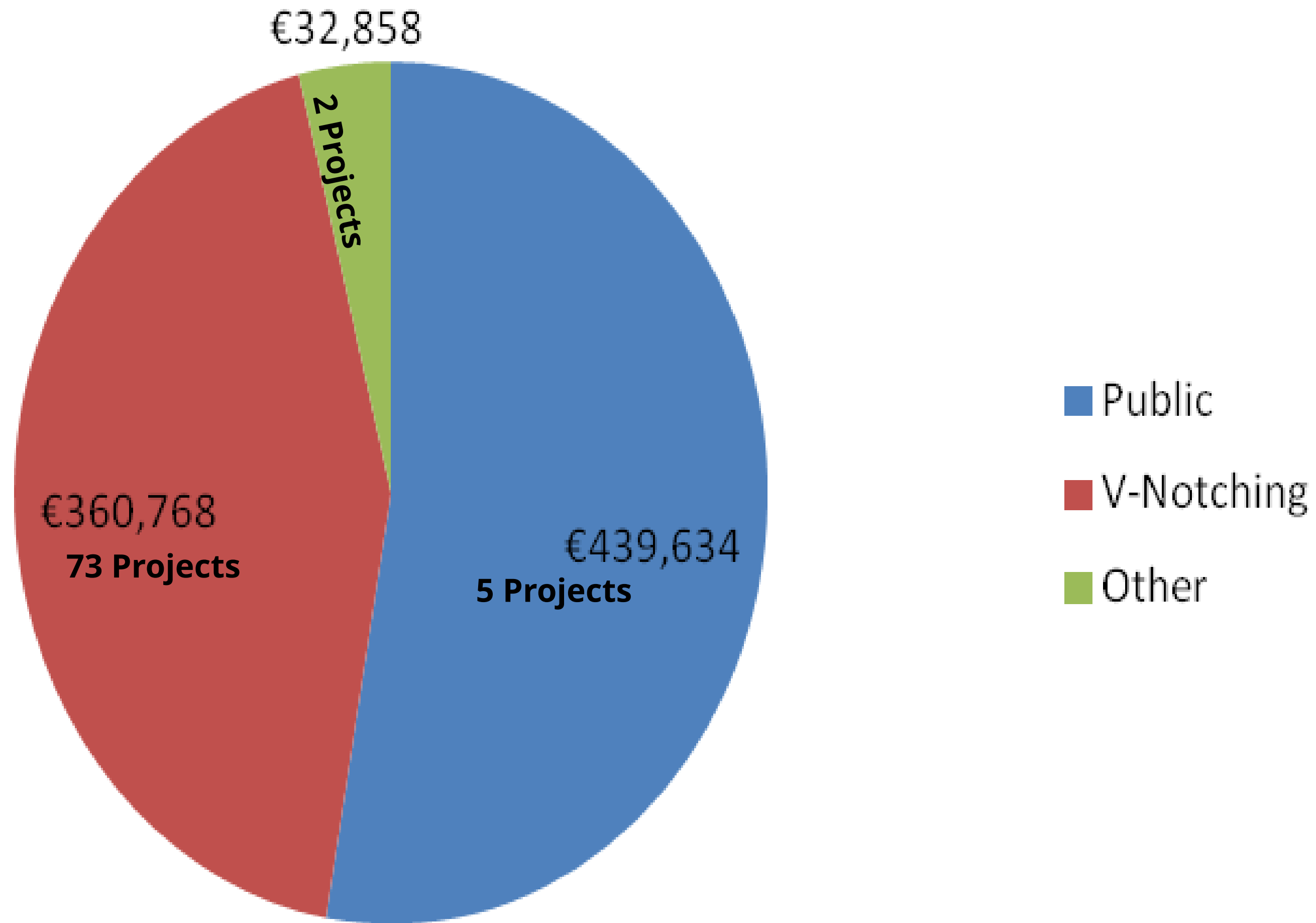

Investment- €833,261 80 Projects

Marine Biodiversity Scheme

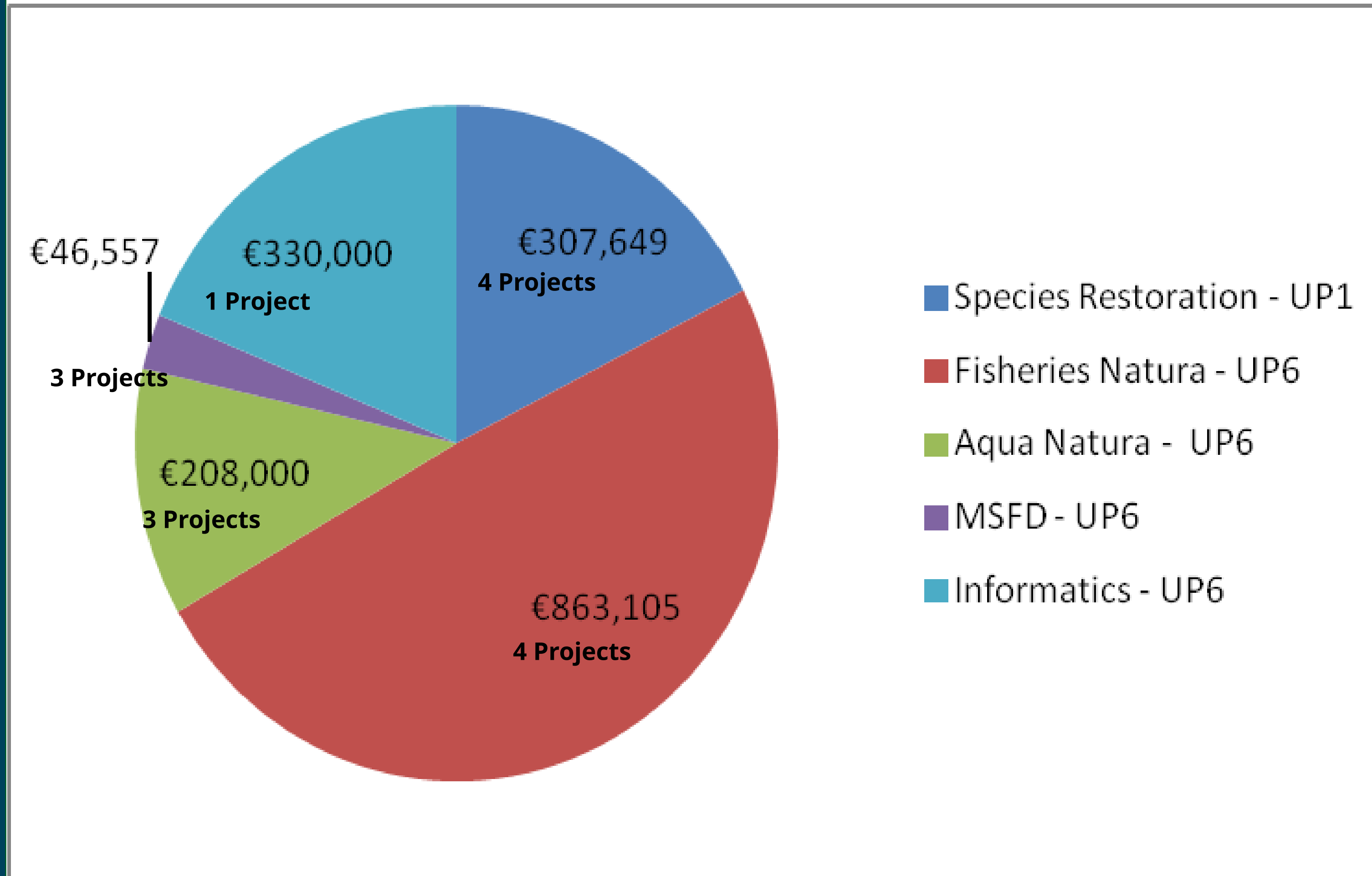

Investment - €1,755,311 15 Projects

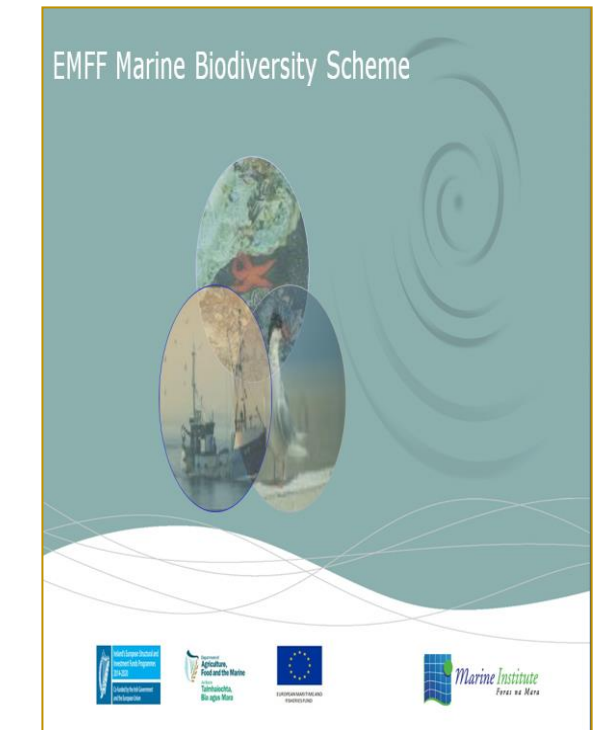

Seafood Innovation Scheme

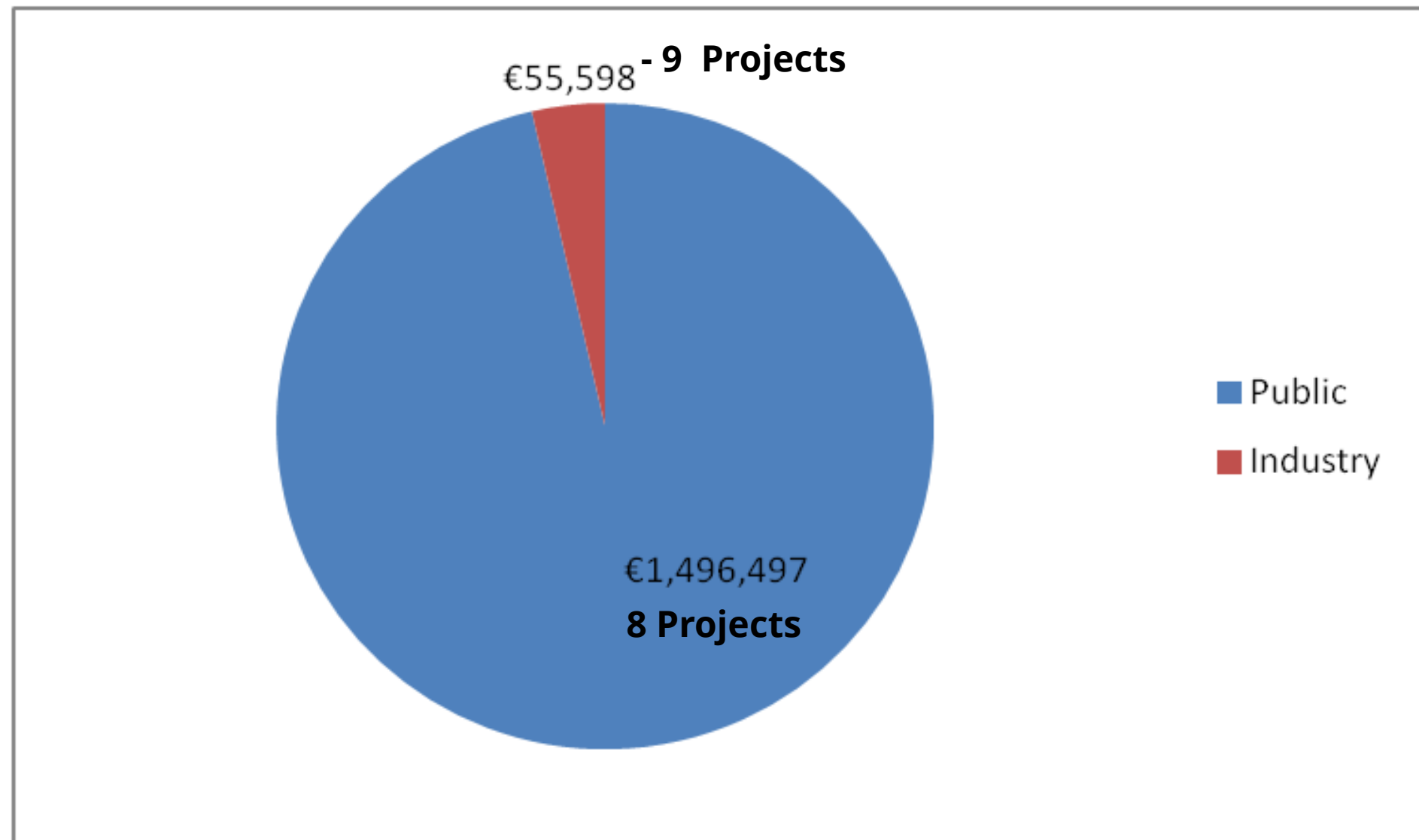

Investment - €1,552,095 17



Seafood Capacity Building Scheme

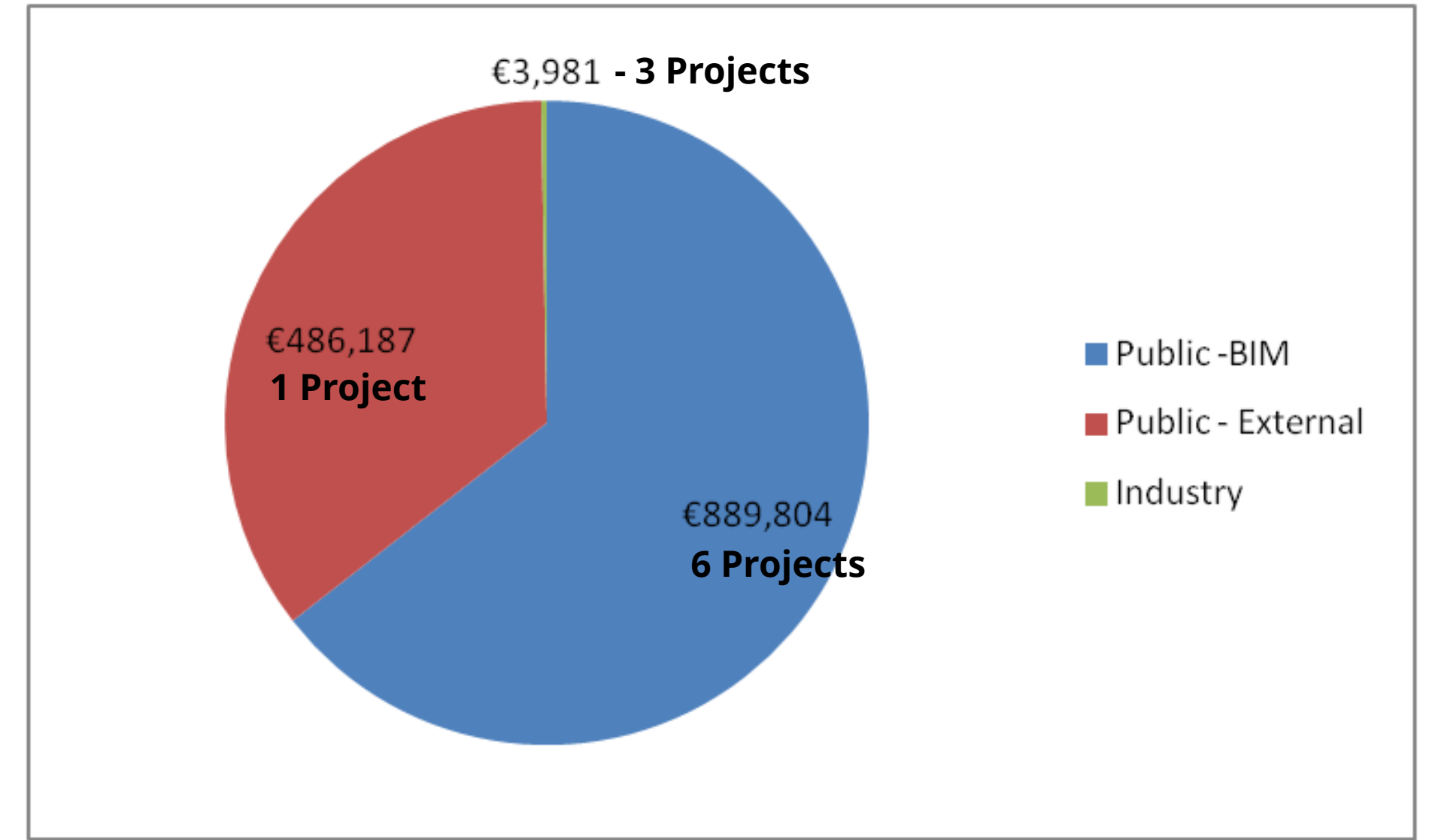

Investment - €1,380,073 10 Projects

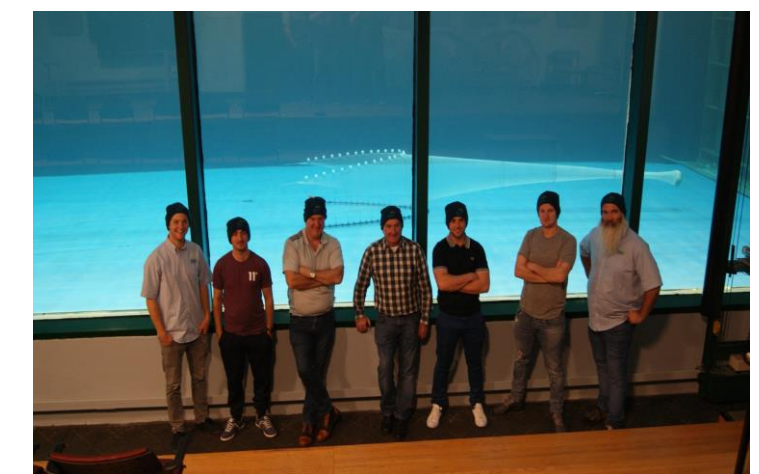

New Fishermen Scheme

8 projects approved for public aid of €375,200

4 projects completed with public aid of €226,700.

Five projects with grant aid of €148,500 will be carried over into 2019.

Fishery Harbour Scheme

2 projects approved for public aid of €14.6 million

Certified Expenditure in 2018 of €7,670,621

Seafood Skills & Training Scheme

59 projects approved for public aid in 2018

In 2018 3 projects were supported with public expenditure of €6,456

Quota Balancing IT system

1 project approved for public aid of €2.0 million

Certified Expenditure in 2018 of €737,232

UP2 Expenditure 2018

■ Knowledge Gateway ■ Sustainable Aquaculture

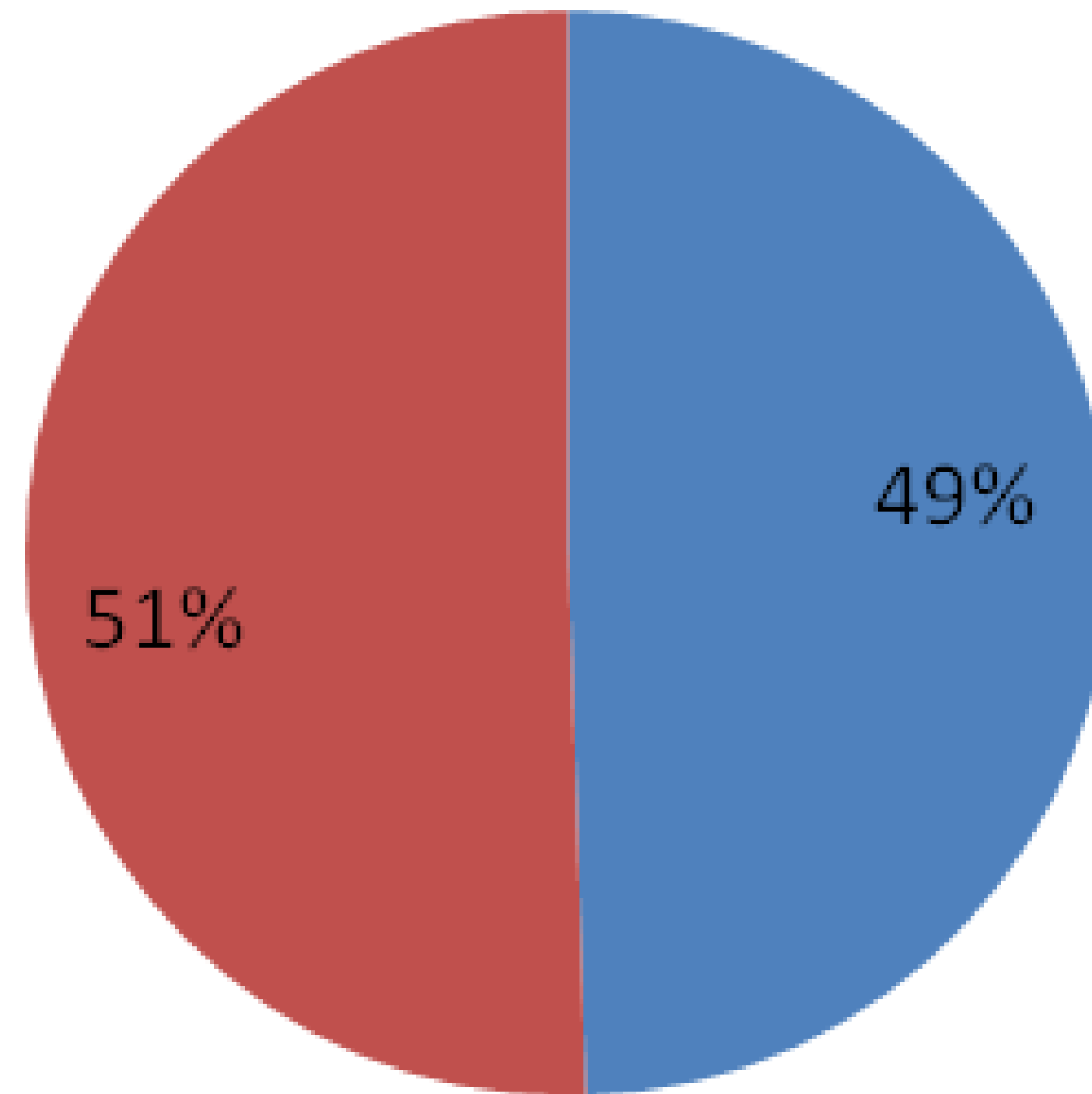

Knowledge Gateway Scheme

Public Projects (22)

IMTA

Seaweed

Scallop

Native oyster

Diseases

Depuration

Research Bodies (6)

IMTA

Seaweed NPD

Scallop

Native oyster

WFD

Animal Husbandry

UCC,
AIT,
NUIG,
BMRS

Investment- €2,538,051 28 Projects

Sustainable Aquaculture Scheme

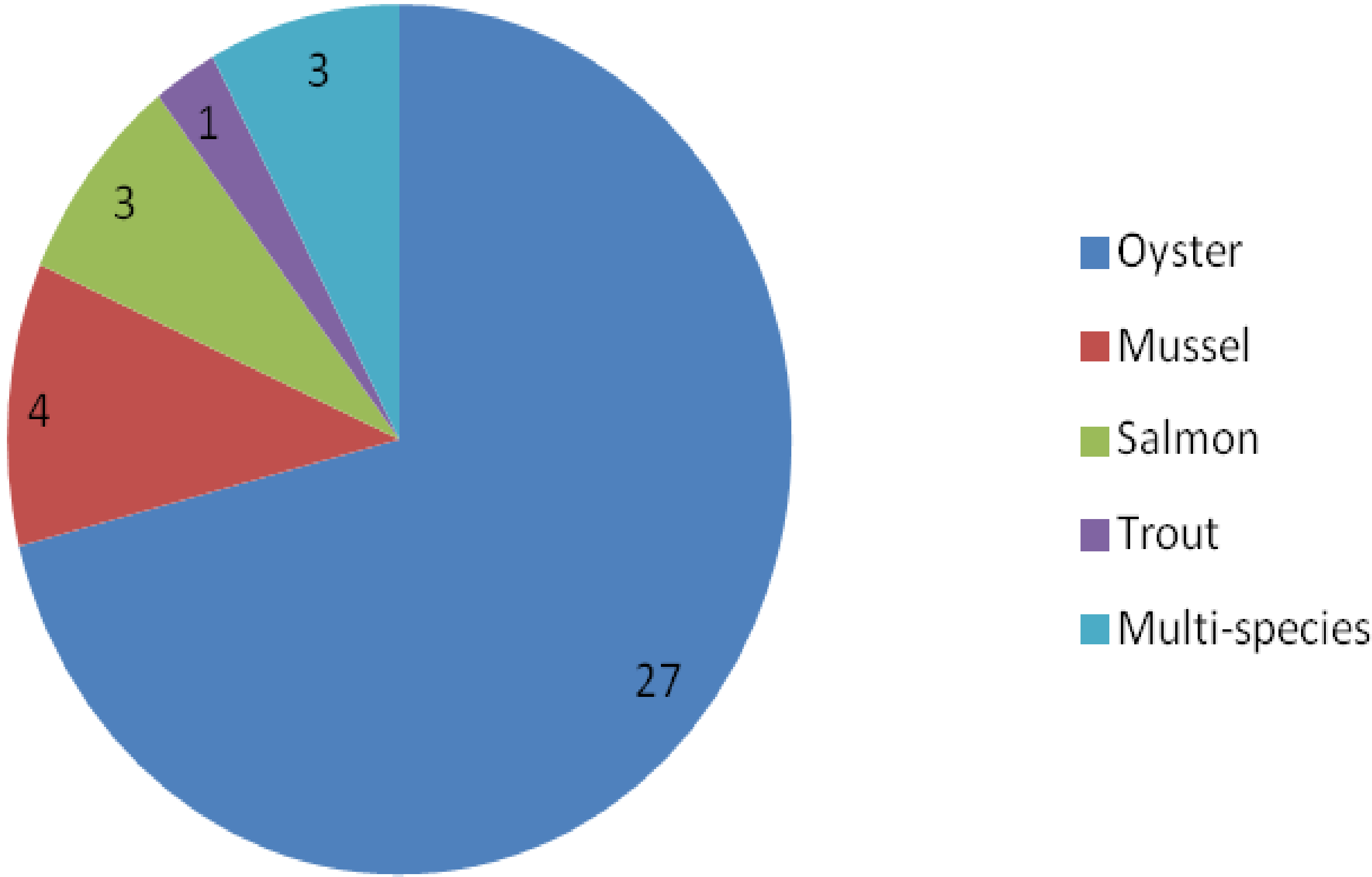

Investment - €2,589,663 38 projects

Control & Enforcement Scheme



€1,140,342



An Roinn Talmhaíochta,
Bia agus Mara
Department of Agriculture,
Food and the Marine

€3,042,928

Phase 2 – IFIS
project

2018 Investment - €4,183,280.9

SFPA approved projects

Grant	Project
€1.8m	ERS Enhancements
€123k	Sales Notes & Flux
€450k	Weighing Official Control Systems
€300k	Audit Assessment
€1m	Technical Assistance
€1.5m	Compliance Promotion
€1m	Vessel Monitoring System on-board vessel unit replacement
€750k	Training and Exchange of staff
€500k	Engine Power Measurement
€60k	FMC
€8.02m	TOTAL

€12.8 million approved for replacement Maritime Patrol Aircraft.

Data Collection Scheme

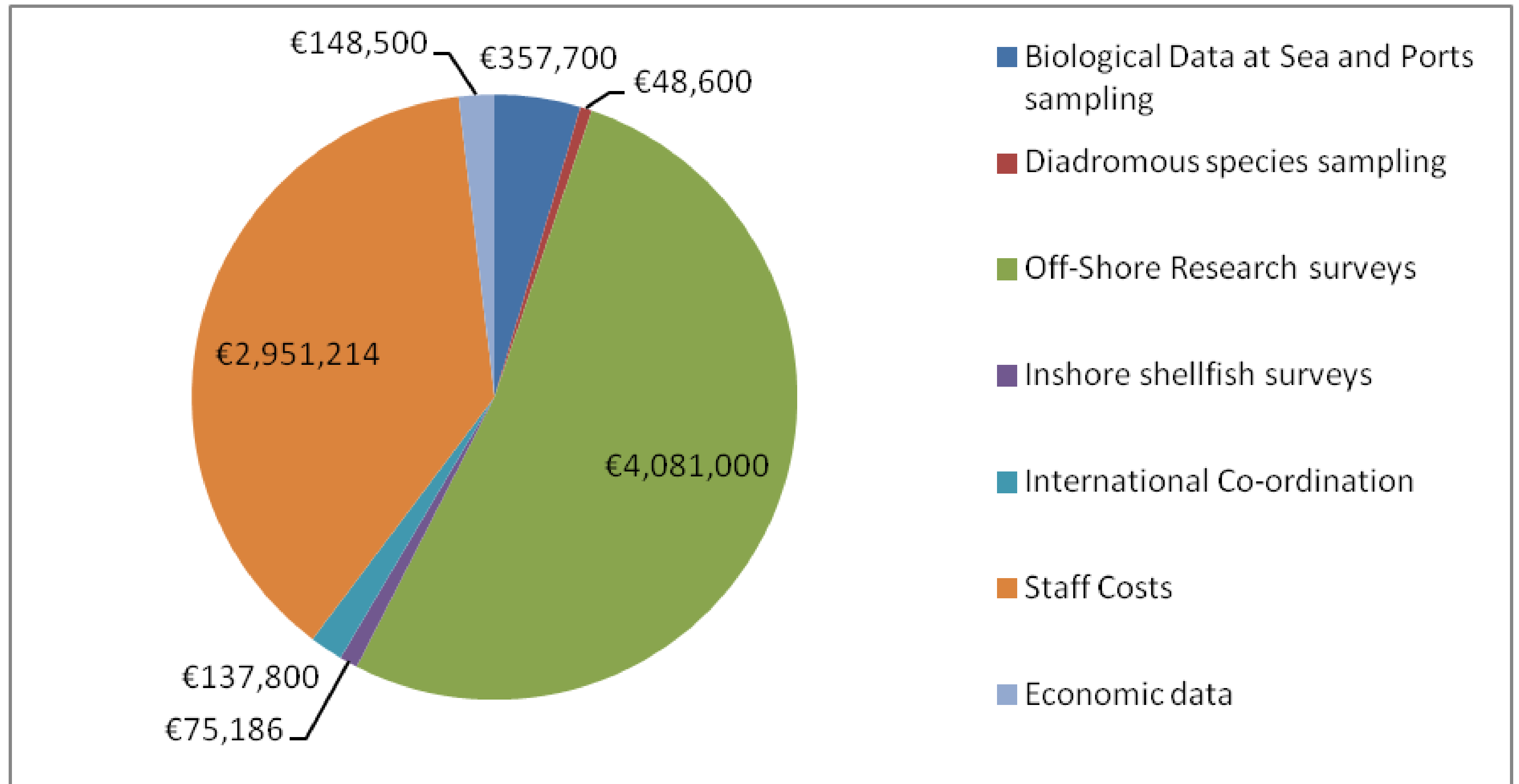

2018 Investment - €7,800,000





FLAG Scheme

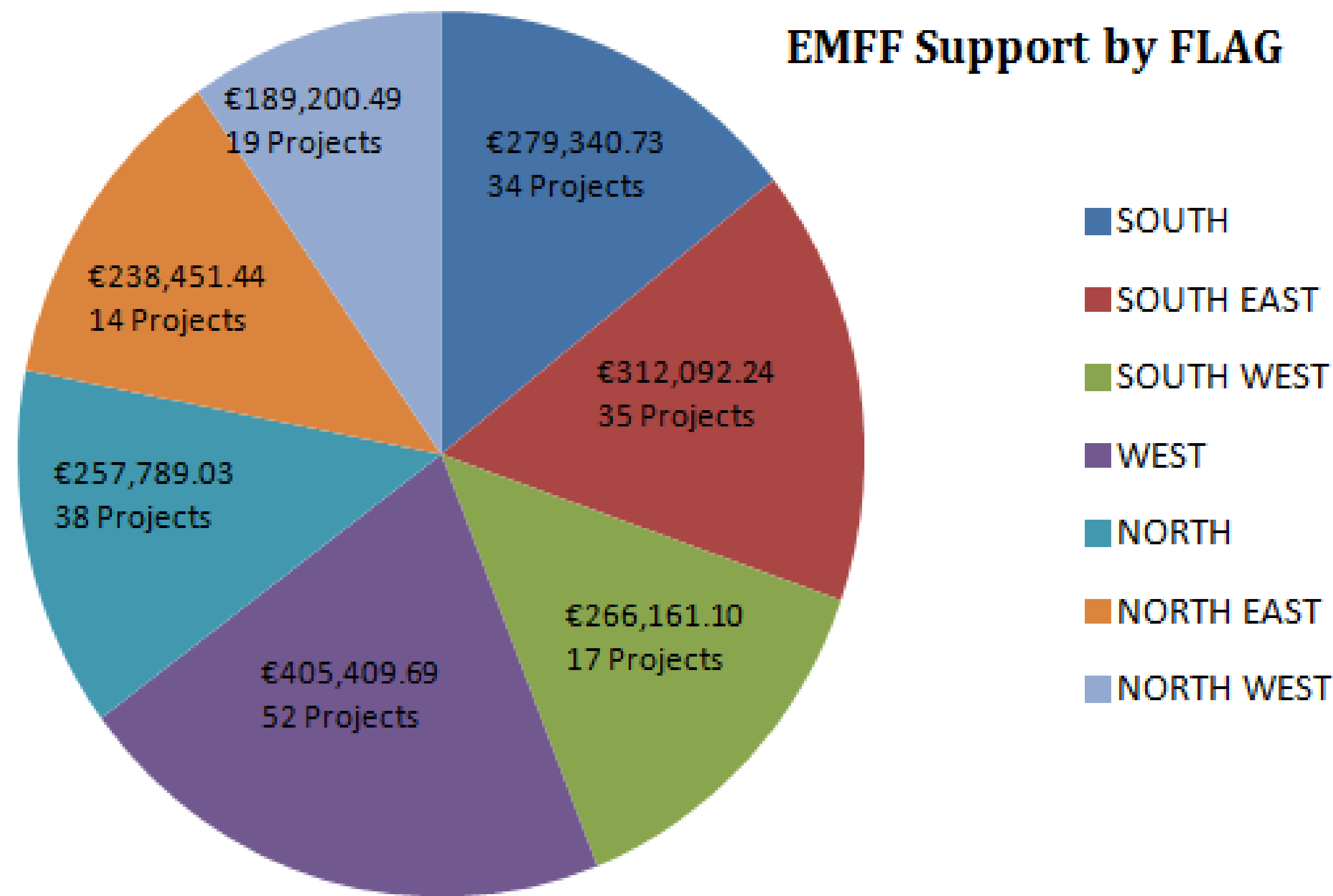

Expenditure UP5 2018

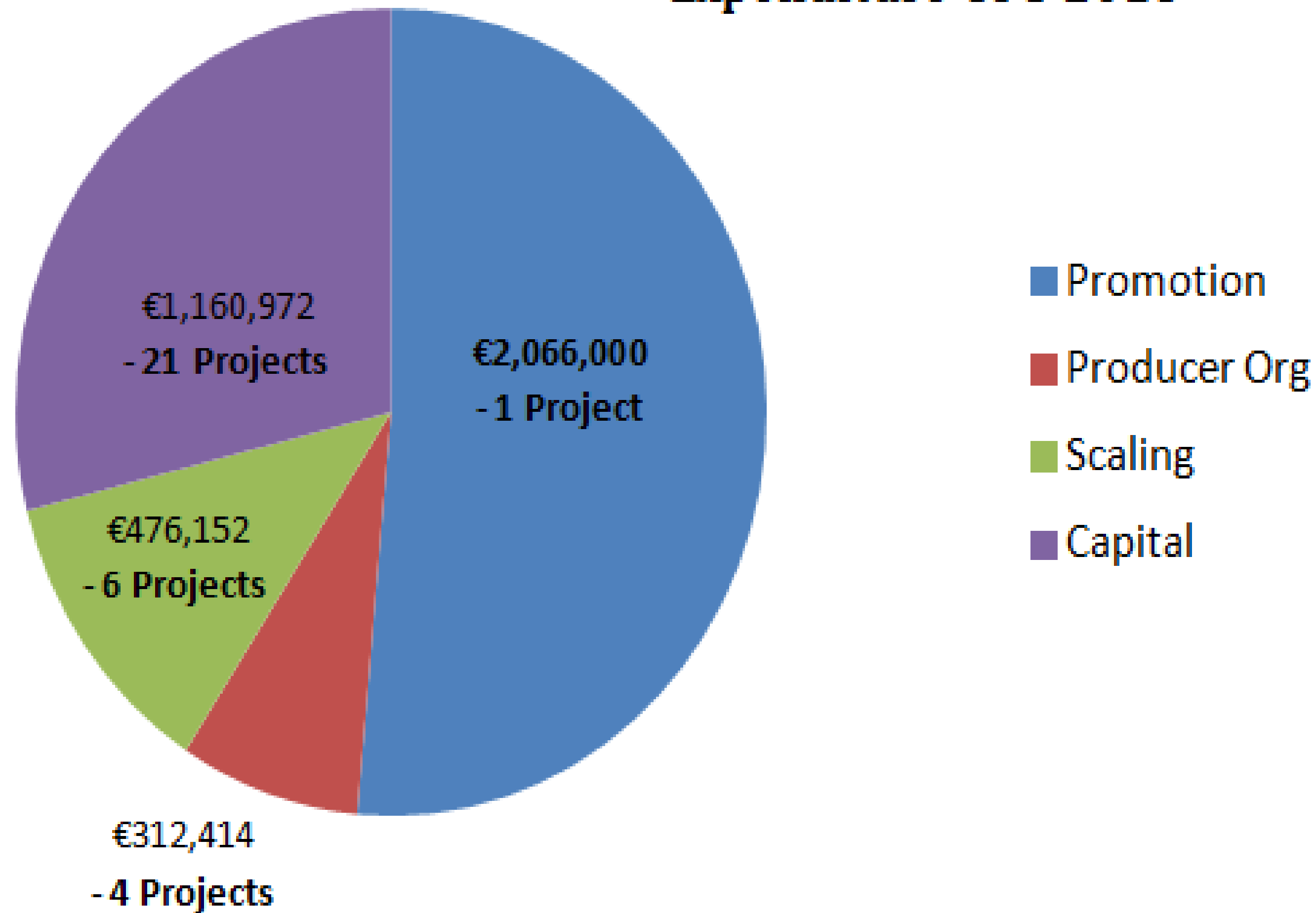

- Promotion of Seafood
- Capital Investment
- Advisory services
- Route to market
- Consumer and Market Research
- Market Development

2018 Investment - €4,015,138 32 projects

Seafood Promotion Scheme

Domestic Market Promotions €400k

'Feet on the Street' €150k

Emerging Seafood Market Promotions €200k

Consumer & International Trade Research €250k

International Trade Exhibitions €1.1mn

Total Grant Awarded in 2018 €2 million

Seafood Scaling & Business Planning Scheme

BIM Projects (4)

Project Atlantic

China Council

Domestic Council

Supply Chain Projects

2018 Investment - €476,152 6



Public Projects (2)

Developing Markets in Asia

Retention of native In-market Consultant

Processing Capital Investment Scheme

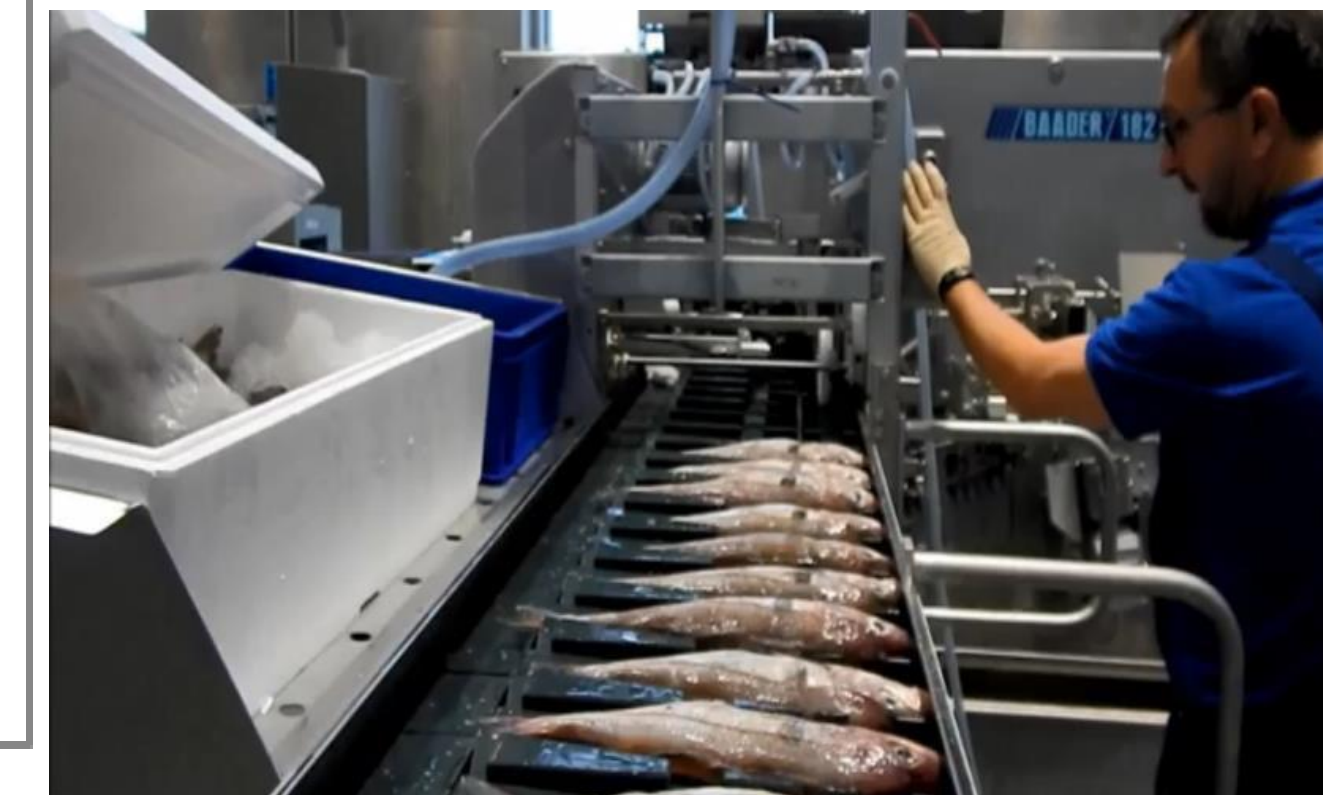
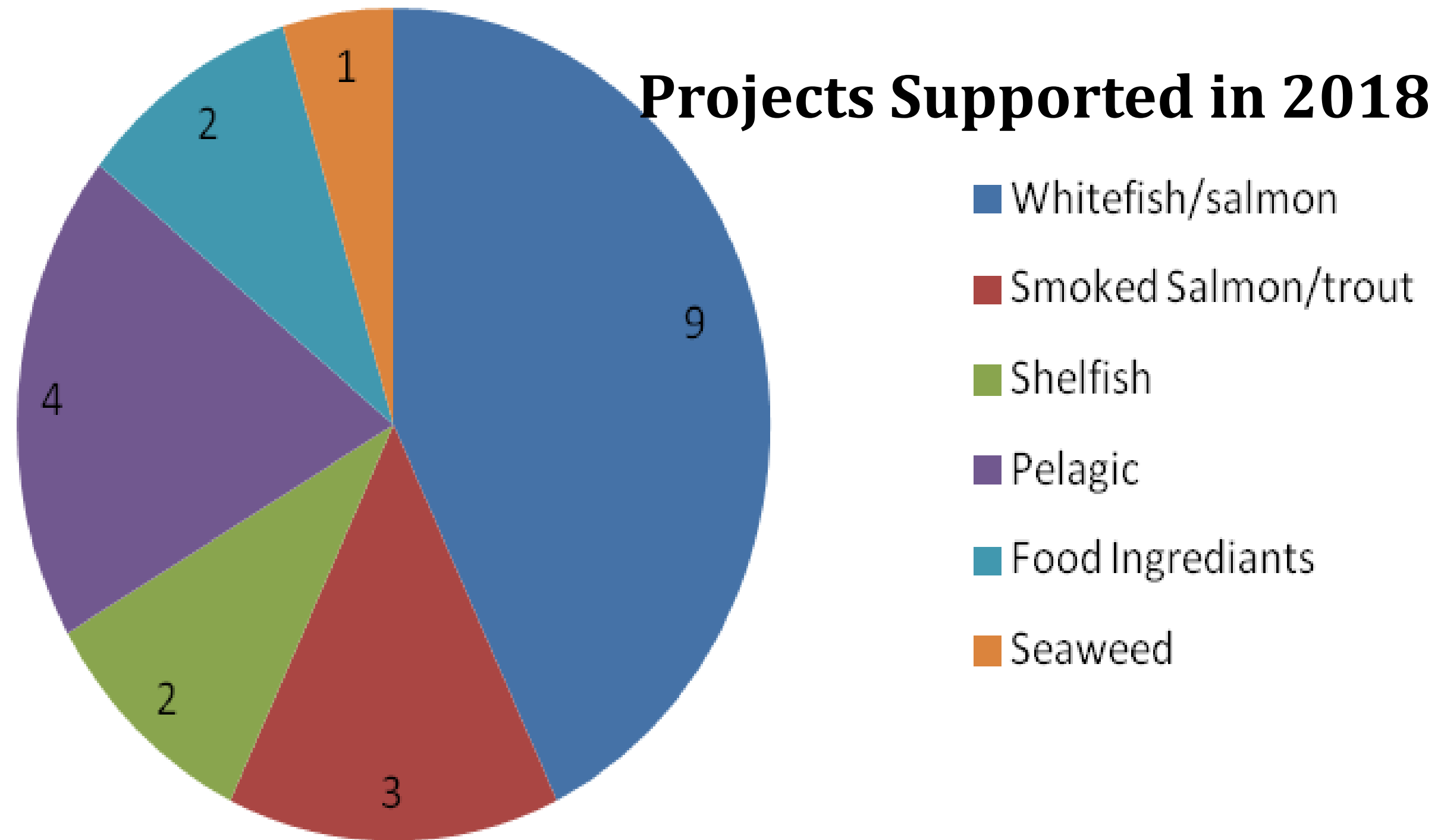

2018 Investment - €1,160,972 21 projects

Producer Organisation Scheme

- Preparation of Marketing Plans and Activity Reports
- Capital Investment – Computer Software and equipment
- Direct staff costs relating to development of PMP
- Route to market
- Consumer and Market Research
- Market Development



2018 Investment - €312,414 4



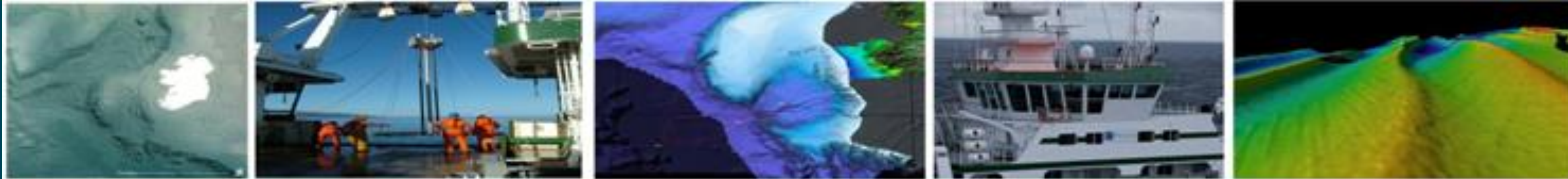

Blue Growth & Marine Spatial Planning Scheme

MI Projects (9)

Spatial Data and Evidence (5)

Data Management and Information Services (2)

Marine Invasive Species Research (2)



2018 Investment - €906,074 9

Technical Assistance

Activities Implemented in 2018

Contracted staff resources

Administration and animation of FLAGs

Information and publicity measures

EMFF training

Costs of the Monitoring Committee.

2018 Investment -

EMFF Performance Framework Update

Performance Framework



Performance Reserve avg 6% of EU Contribution

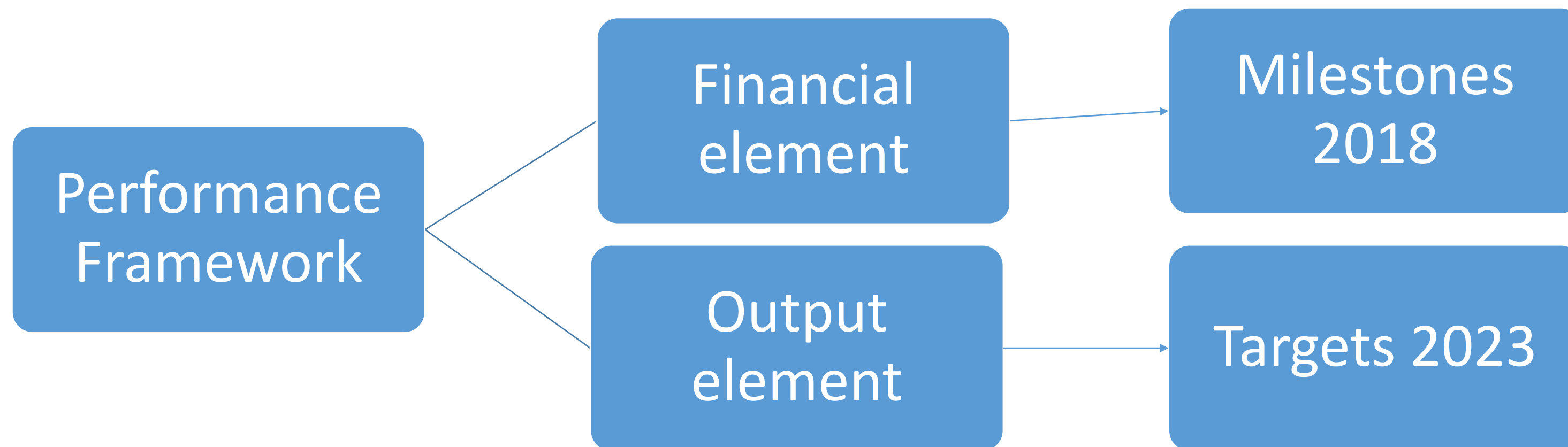

	Budget	PF Reserve
Union Priority 1	55,590,000	1,675,600
Union Priority 2	29,800,000	745,000
Union Priority 3	84,924,202	4,759,280
Union Priority 4	12,000,000	300,000
Union Priority 5	38,281,587	1,109,355
Union Priority 6	10,669,344	266,884

Performance Framework - Financial €m



	Milestone	85% of Milestone must be achieved by end 2018	Certified spend by end 2018	Actual Spend by end of 2018	
Union Priority 1	€14m	€11.9m	€14.4m	€23.0m	√
Union Priority 2	€5m	€4.2m	€4.9m	€8.5m	√
Union Priority 3	€40m	€34.0m	€33.5m*	€45.9m	√
Union Priority 4	€3.75m	€3.2m	€3.6m	€3.6m	√
Union Priority 5	€10.5m	€8.9m	€8.5m*	€13.5m	√
Union Priority 6	€2m	€1.7m	€3.8m	€3.8m	√
		TOTAL	€68.7m	€98.3m	

* If more than 2 Indicators in a priority then a 75% threshold may be applied to 1

Performance Framework (Output)



	Focus Area	Milestone	Milestone 85%	Achieved by end 2018	
UP 1	Fisheries Innovation, Stock Conservation, Selective Gear	25	21	23	√
	Marine Biodiversity	18	16	200	√
	Training, New Fishermen, H&S	30	26	59	√
	Quota Management	1	1	1	√
UP2	Aquaculture Innovation & Advice	50	43	48	√
	Capital Projects Aquaculture	25	22	78	√

Performance Framework (Output)



	Focus Area	Milestone	Milestone 85%	Anticipated to end 2018	
UP 3	Control	1	1	13	√
	Data Collection	1	1	2	√
UP4	FLAGs	7	6	7	√
UP5	Marketing	3	3	28	√
	Processing (capital)	40	34	73	√
UP6	MSP & Marine Biodiversity	2	2	19	√